

Wink Flange 82 LED GE

14203009 14203032

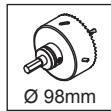
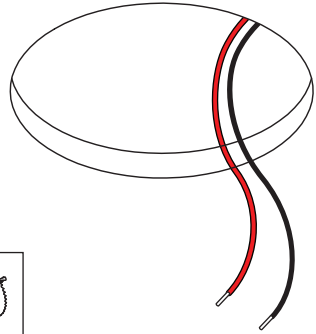

Drive Current (mA)	Forward Voltage		Power (W)
	min (Vf)	max (Vf)	
350	16,5	19,2	6,2
500	17,1	19,8	9,2

For serial connection, respect polarity!

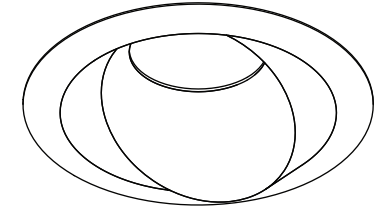
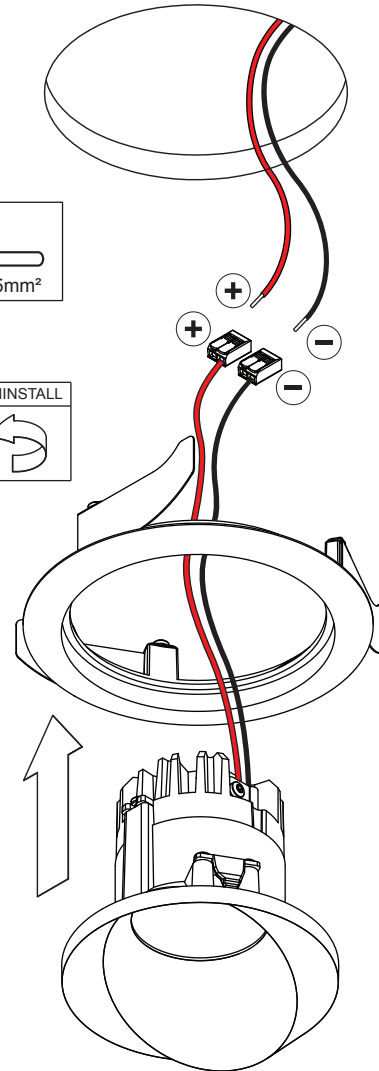
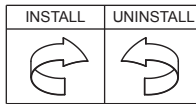
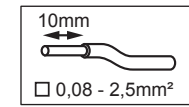
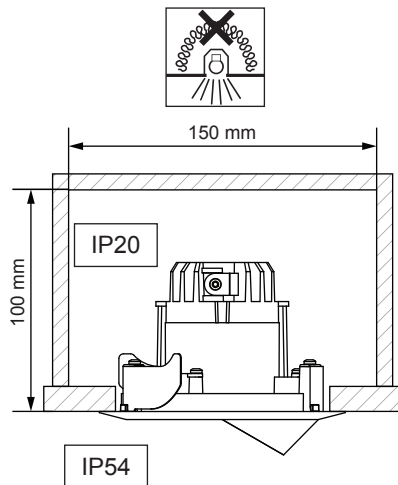

Replace protective shield when broken. The luminaire shall only be used complete with its protective shield.
Reference number: 1011764 - ASY 1012931

LIGHT SOURCE - DO NOT TOUCH LED
Touching the LED can result in permanent damage of the light source. The light source contained in this luminaire shall only be replaced by the manufacturer or his service agent or a similar qualified person.

PREVENTING ELECTROSTATIC DAMAGE
A discharge of static electricity may damage sensitive components. Always be properly grounded when touching leads or circuitry inside the luminaire. Use a wrist strap connected by a ground cord to the housing. Avoid touching the light sources with bare hands.

DRIVERS & ACCESSORIES
For latest version of driver matrix and available accessories check www.supermodular.com or connect with your sales contact.

